

The battery is manufactured with PVC-SiO₂ separator and colloidal or fumed silica. The tubular positive plate and pasted negative palte is applied. The batteries use silica gel to immobilize the electrolyte inside the battery. The proven silica gel technology improves battery cycle life and performance at various ambient temperatures.

General Feature

- The battery has a long service life, under float charging, ambient temperature 25 °C, it can operate 15-20 years .
- Excellent Recovery from deep discharge and good deep discharge cycle capability.
- the battery has a low self-discharge, keep over 60% of the rated capacity after 2 years stored under 25 °C
- High Reliability and Quality

Battery Construction

Component	Positive plate	Negative plate	Container	Cover	Safety valve	Terminal	Separator	Electrolyte
Raw material	Tubular	Lead	ABS	ABS	Rubber	Copper	PVC-SiO ₂	Fumed silicon

SPECIFICATION

Nominal voltage	2V
Number of cell	1
Length(mm/inch)	206/8.11
Width(mm/inch)	145/5.71
Height(mm/inch)	645/25.4
Total Height(mm/inch)	671/26.4
Approx. Weight (kg/lbs)	50/110.0

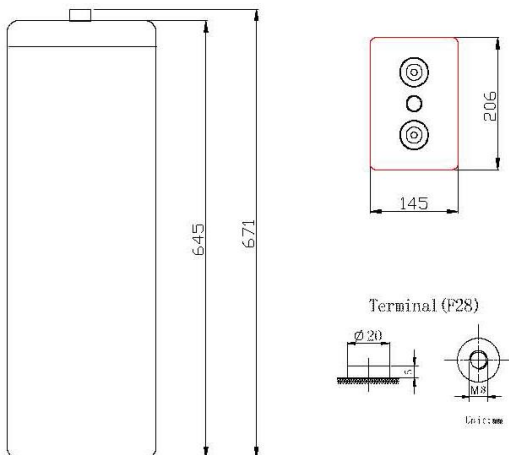

Performance Characteristics

Capacity 77°F(25 °C)	240 hour rate (3.3A、1.85V)	799Ah
	48 hour rate (15.6A、1.85V)	750Ah
	10 hour rate (60A、1.8V)	600Ah
	3 hour rate (156A、1.6V)	468Ah
Internal Resistance	Full charged Battery 77°F(25 °C): 0.35mΩ	
Operating Temperature Range	Discharge: -20~65 °C	
	Charge: -10~65 °C	
	Storage: -20~65 °C	
Self-Discharge 1.5% of capacity declined per month at 20 °C (average)		
Max. discharge current 77°F(25 °C): 2500A(5S)		
Charge (Constant Voltage)	Float: 2.23~2.27 V/77 ° F/(25 °C)	
	Cycle: 2.38~2.42 V/77°F/(25 °C) Max. Current: 90A	

www.store-ace.com All specifications are changed without notice

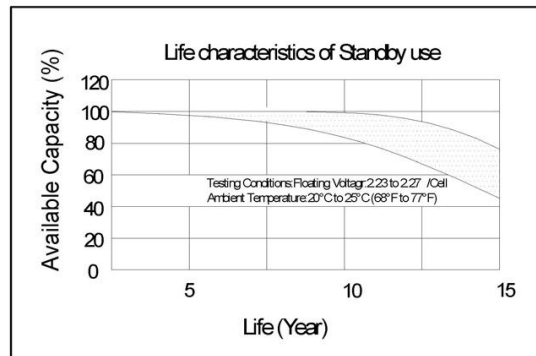
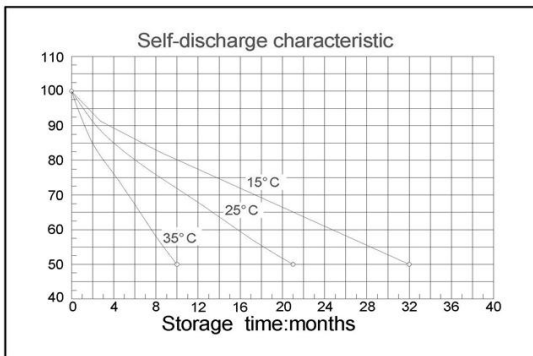
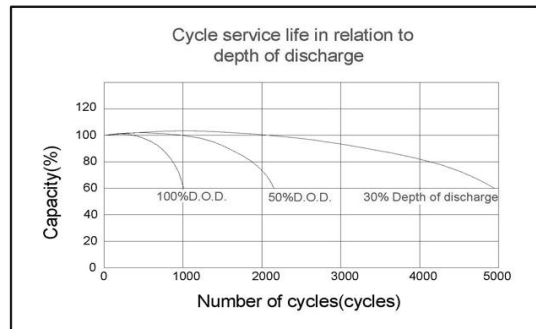
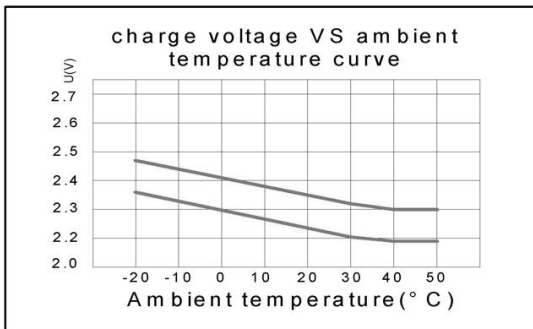
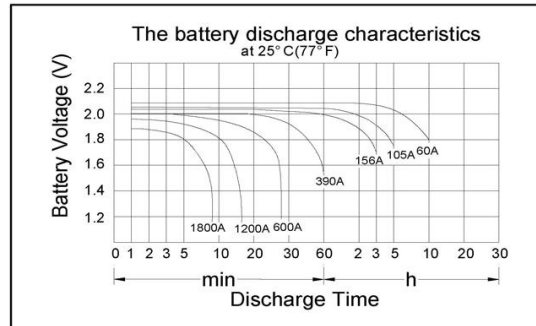
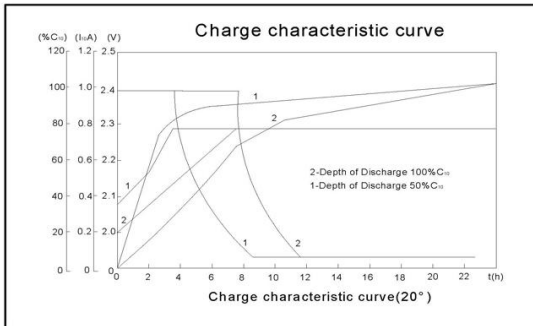

Discharge Constant Power (watts at 77° F 25°C)

End Point Volts/Cell	15min	30min	1h	3h	5h	10h	24h	48h	120h
1.65V	1474	1100	704	321	226	---	---	---	---
1.70V	1334	1100	663	311	214	---	---	---	---
1.75V	1258	948	621	307	208	122	---	---	---
1.80V	1182	895	609	299	200	119	---	---	---
1.85V	1106	813	584	282	195	113	55.5	31.0	13.1

Discharge Constant Current (Amperes at 77° F 25°C)

End Point Volts/Cell	15min	30min	1h	3h	5h	10h	24h	48h	120h
1.65V	75.6	56.4	35.4	161	113	---	---	---	---
1.70V	68.4	51.3	33.3	15.6	10.7	---	---	---	---
1.75V	64.5	48.6	31.2	15.4	10.5	61.2	---	---	---
1.80V	60.6	45.9	30.6	15.0	10.1	60.0	---	---	---
1.85V	56.7	41.7	29.3	14.7	98.1	56.7	27.9	15.6	6.6

All specifications are changed without notice

www.store-ace.com